



April 13, 2020

The Good News from Trinity PC

**Church Worship Services
and Activities are cancelled
through April 26.**

**Watch the newsletter for when they
will resume.**

**Office Open
9:00-Noon Monday-Thursday**

**Prayer Requests can be emailed to:
office@trinitypresbyfairfield.org**

Christ Has Triumphed!

Tomb, thou shalt not hold him longer;
Death is strong, but life is stronger.
Stronger than the dark, the light;
Stronger than the wrong, the right.
Faith and hope triumphant say,
Christ will rise on Easter Day.

—Phillips Brooks

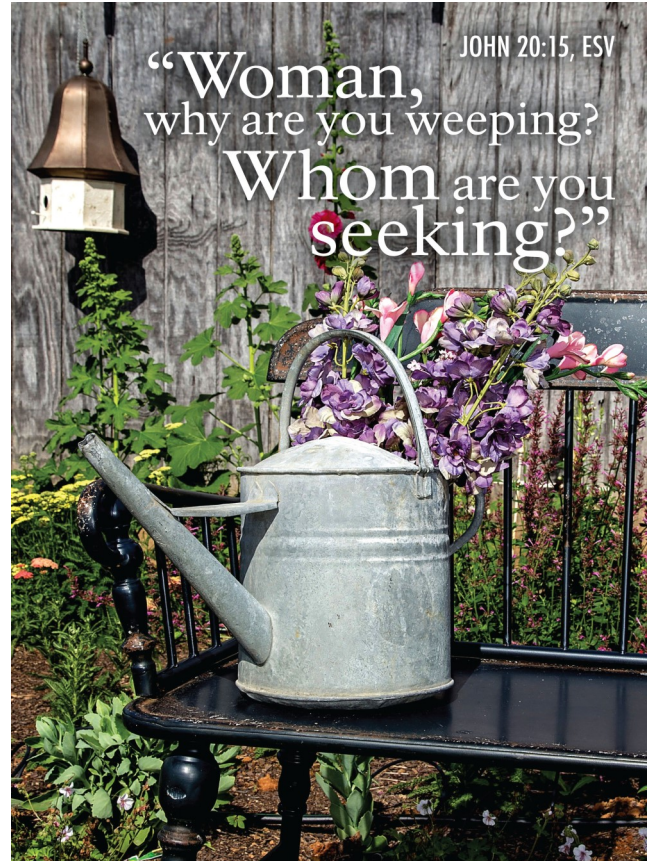

Life Everlasting

Fellowship with Christ is participation in the divine life which finds its fullest expression in triumph over death. Life is a larger word than resurrection; but resurrection is, so to speak, the crucial quality of life.

—William Temple

**We thank, Worship Leaders for their
service:**

**All Worship Volunteer Leaders please watch
future Newsletters to know when the
Worship Schedule will resume.**



Trinity Presbyterian Church

Rev. Tom Dunlap Pastor

6081 Ross Road
Corner of Ross and Mack Roads
Fairfield, Ohio 45014

Phone: 513-860-4114
www.trinitypresbyfairfield.org E-mail:
office @trinitypresbyfairfield.org

**Prepare for Worship
2nd Sunday of Easter**

1 Peter 1:3-9

“Blessed be the God and Father of our Lord Jesus Christ! By his great mercy he has given us a new birth into a living hope through the resurrection of Jesus Christ from the dead, and into an inheritance that is imperishable, undefiled, and unfading, kept in heaven for you, who are being protected by the power of God through faith for a salvation ready to be revealed in the last time. In this you rejoice, even if now for a little while you have had to suffer various trials, so that the genuineness of your faith—being more precious than gold that, though perishable, is tested by fire—may be found to result in praise and glory and honor when Jesus Christ is revealed. Although you have not seen him, you love him; and even though you do not see him now, you believe in him and rejoice with an indescribable and glorious joy, for you are receiving the outcome of your faith, the salvation of your souls.”

Reflection

According to the gospel, Christ’s wounds were not erased by the resurrection. In fact, he invites Thomas and the other disciples to touch his wounds to bring the disciples back to faith. How might we in the church use our wounds to help others come to faith?

Morning Prayer

Holy One, you have made known to me the ways of life and have promised to fill me with the gladness of your presence. Keep me mindful of your guidance and your promise as I travel through this day, that my heart may be glad. Amen.



Celebrations

April Birthdays

Dee Burkhardt	April 2
Lory Love	April 8
Nodvi Tenga	April 13
Hannah Ntube	April 14
Michel Tenga	April 18
Debi Hess	April 26
Diane Rayer	April 27
Mireille Tenga	April 29

Early May Birthdays

Gina Anaple	May 1
Dallas Wiggins	May 13
Valentine Nyamusa	May 17
Gary Anaple	May 18
Judy Huber	May 20

Early May Anniversaries

Donna and Kurt Schuler	May 1
Glenn and Marta Mojzer	May 14
Cindie and Ken Postell	May 20

Like the nine cleansed lepers (Luke 17:11-19), Lord, too often we take your gifts for granted. Remind us to praise you for all we are and all we have.

Thank you for another Birthday to celebrate!

—adapted from *Feasting on the Word Worship Companion: Liturgies for Year A, Volume 1* © 2013 Westminster John Knox Press

Rev. Dunlap's Sermons on-line

Pastor Dunlap has recorded his message for Easter Sunday and it is on the Trinity web page at the link below. To hear the message, simply click on the play button on the April 12, 2020 Easter player at the web page link. You may also click on the PDF next to the player to read along.

<http://www.trinitypresbyfairfield.org/april-2020.html>

Deacons, as always please pass on the email link to everyone in your care groups.

Suggestion from the treasurer:

In the next couple of weeks nearly all of us will be receiving a stimulus check from the federal government. Some of us have not been nor will we be financially impacted by the current coronavirus situation. For example those of us who are retired and on a fixed income will not suffer any loss of income because of unemployment. While each person's situation is different and family needs differ accordingly, I am suggesting that we prayerfully consider tithing (that is giving 10% of the stimulus check to the church's general fund.

Lenten Mission Project

The Lenten "bag" collection of items for the food pantry and the non-food pantry can be dropped off at the church Monday through Thursday from 9:00-noon.

Missions at Work

- ◆ Sewing of dresses for Mission Project in Appalachia will be held the 2nd Tuesday of the month at 10:00 AM
- ◆ Knitters /Crocheters: Mercy and our church are in need of prayer shawls and baby blankets.
- ◆ Collecting plastic lids, soda pull tabs, and cancelled stamps

Uplifting Sources

There are a myriad of online devotions available as well.

"Devotions on the go - www.d365.org" This is a free online daily devotional provided by the Presbyterian Church (U.S.A) and an app is available for cell phones.

"Dial Hope"- An alternative to the digital world and online. You can listen to a brief message and prayer by calling 866-528-4673. Also available online www.dialhope.org The messages are prepared and read by Joe Albright, a Presbyterian pastor from Florida.

"Our Daily Bread" - www.odb.org - Daily devotions free online. —Lisa Allgood, *Cincinnati Presbyterian*

Additional resources from the Presbytery to help us through the present situations:

- City Gospel, Cincinnati Area Senior Services (www.cassdelivers.org) as resources, especially for family and senior needs.
- United Way has announced an emergency relief fund for help with bills, rent and food (call 1-866-211-9966 and provide a zip code).
- Many rental agencies as well as Duke Energy and GCWW have suspended stopping service for non-payment for the time being.
- Spectrum is offering free internet to students without it for study.
- O-Pi-O is offering free lunches to school age children.

"I pray that God, the Source of hope, will fill you completely with joy and peace because you trust in Him. Then you will overflow with confident hope through the power of the Holy Spirit". Romans 15:13

PASTORAL LETTER

As we proceeded through Holy Week, I experienced a kaleidoscope of emotions. There was the joy with the coming of Easter and the hope that it brings to our world which is immersed in the life altering virus. And I felt excited about virtually sharing Maundy Thursday and then the resurrection with you. But in the swirl of these uplifting feelings, I kept getting snagged on sadness. For on this week more than any other since we began our separation, I was keenly feeling the loss of our community. I am writing this on Easter afternoon and I keep thinking about the breakfast we missed this morning and the spiritual energy generated by our worship, singing and praising God together. And next weekend was to have been my son's wedding in Pittsburgh. Thump!

But this is just the tip of the iceberg of the grief we shall all be experiencing in coming days, weeks and months ahead as our losses accumulate and come more into focus. Right now we are appropriately concentrating on just getting through this period of social isolation. We hear promising reports of flattening curves and this is all very hopeful. Perhaps we can begin worshipping together next month?? We'll see. But the way we relate to each other has profoundly changed. Wearing masks and avoiding others is altering our relationships. While being careful around other people is totally necessary, our attitudes toward our neighbors is subtly changing. We look at each other with wary eyes. And we dare not touch! We shall have to deal with this and we will. But it is sad. And I just want to note that the scriptures are replete with plagues, disasters, slaughters, wars, executions...you name it. They are all part of the human experience. It is so real! The future will be different and we will all be part of the changes that are coming. We can trust that God will be there—and so will you and I...TOGETHER.

Have a blessed week, everyone!

Tom

Mid Week Reflection



*Doubting
Thomas*

Seeing Jesus

Scripture: John 20:19-31

Doubt

But he said to them, “Unless I see the mark of the nails in his hands, and put my finger in the mark of the nails and my hand in his side, I will not believe.”

Doubt is a very important part of faith. If handled lovingly, doubt can be a wonderful catalyst into a *deeper* faith. But I’ve always found it peculiar that Thomas doubts his friends in this passage from the Gospel of John. I would have guessed that he would trust his colleagues and believe what they told him.

But Thomas is traumatized and very, very scared. His teacher has died, and he’s worried that they are all at risk. Thomas feels deeply disappointed, and he does not even trust his friends. He wants proof. Can you blame him? Thankfully Thomas keeps showing up until he really does see Jesus. God invites us to keep showing up and to work through our doubts and into a deeper place of faith.

Loving God, help me to trust in you, in spite of my doubts and my fears, so that I might be led into a deeper and more profound faith. Amen.

Kate S. Forer, Saratoga Springs, New York
These Days, a quarterly devotional
—permission granted by pcusa.org

The kingdom of heaven
is like a net full of fish.

Match the fish below.

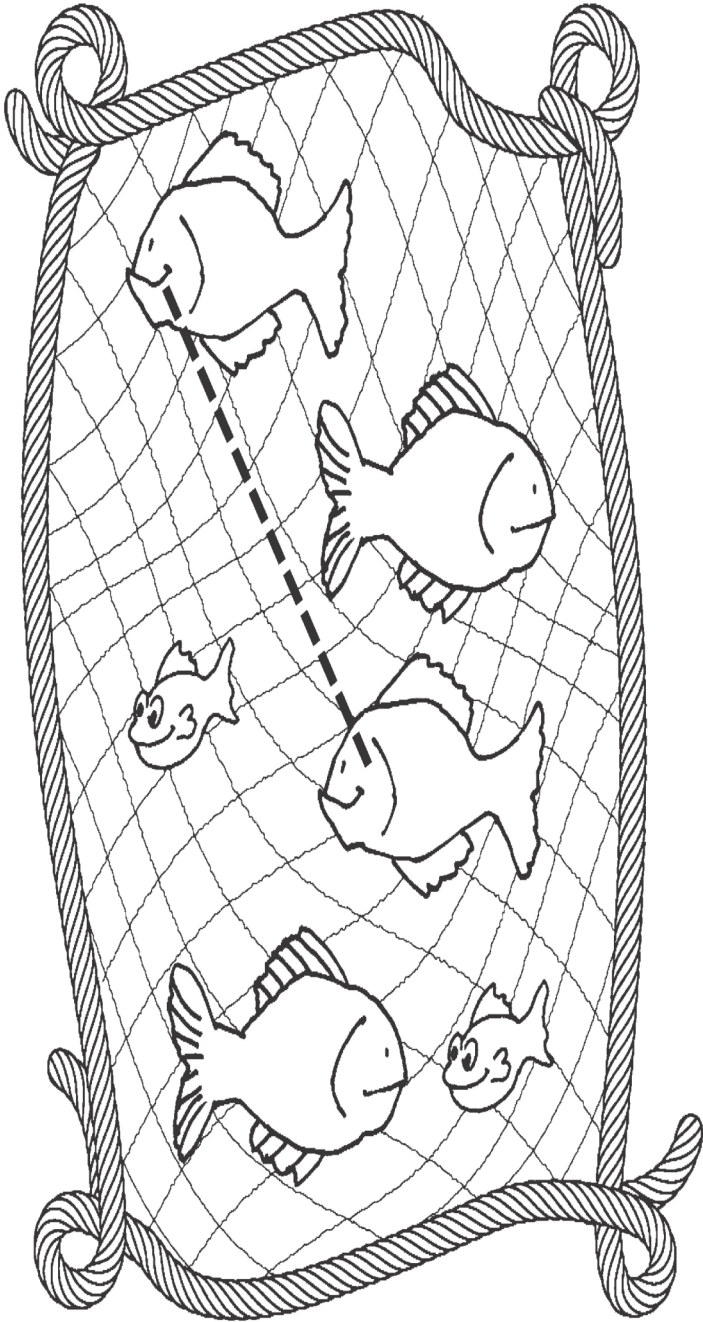

Children's Worship Bulletin™



Ages 3+

Matthew 13:31-33, 44-52

Jesus Teaches With Parables

Jesus taught about the kingdom of heaven
while He was in the boat.

Connect the dots.
A B C D E F G H I J K L M N

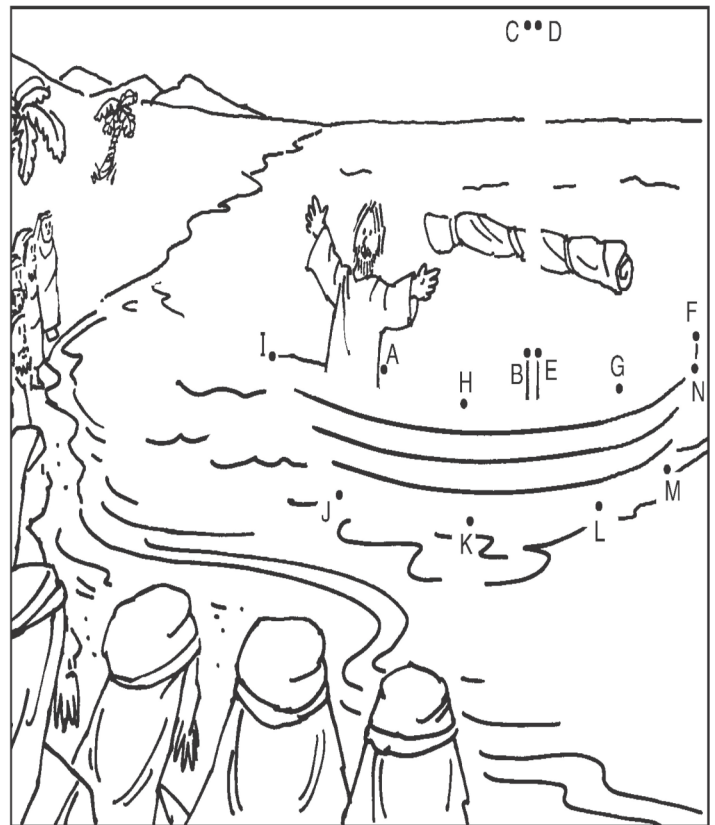

The kingdom of heaven is like a tiny mustard seed that grows into a large tree.

Count the birds in the tree. **Circle** the right number.



3 5 7

The kingdom of heaven is like a hidden treasure.

Find these treasures hidden in the picture below.

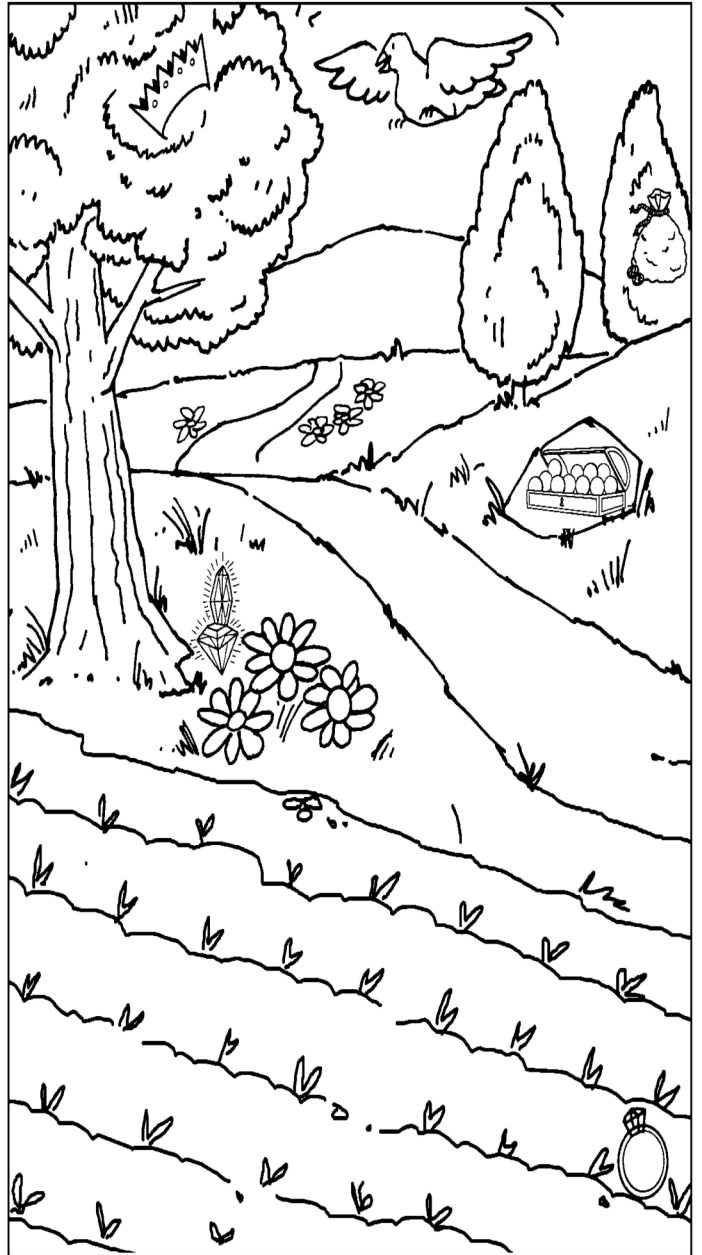



Jesus prayed for His friends.

Children's Worship Bulletin™

Ages 7+

John 17:1-11

Jesus Prays

Jesus prayed to His Father in heaven.

Find 10 things that are different in the second picture.

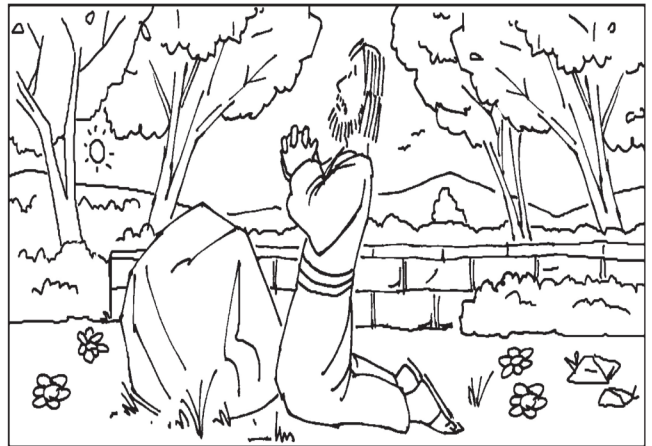

Use the code to find some of His words.

○=A	◐=E	◑=I	◒=M	▢=Q	◻=U	⊠=Y
◑=B	◐=F	◒=J	▣=N	⊠=R	◻=V	◑=Z
◐=C	◑=G	◑=K	▢=O	⊠=S	◻=W	
◐=D	⊠=H	◐=L	◻=P	◑=T	◻=X	

He said, “



”

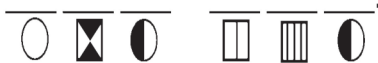

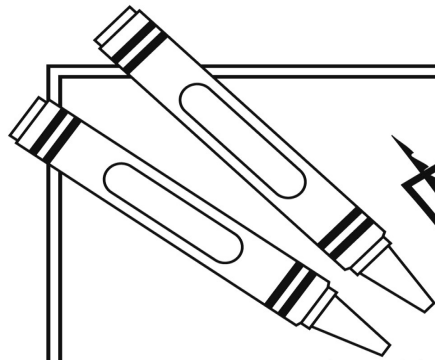





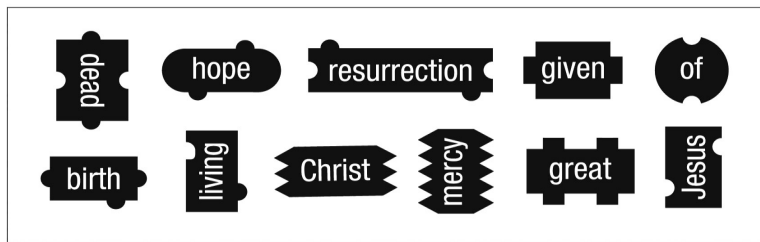

PUZZLE

> NEW LIFE <

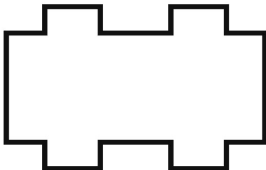
How did God work through Jesus to give us new life at Easter?

Directions: Use the puzzle pieces from the box to complete 1 Peter 1:3, NIV.

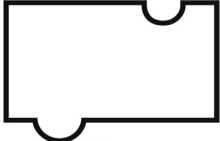
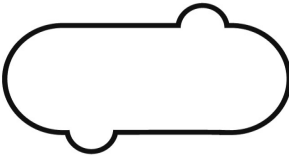
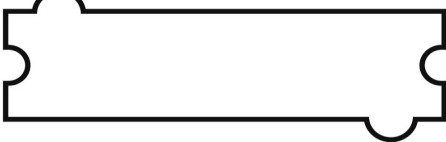
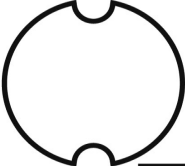
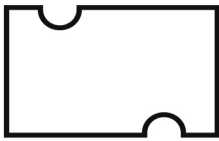

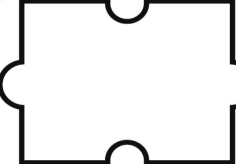
In his   he has
 us new  into a
  through the
  
 from the .

1 P E T E R 1 : 3 , N I V

Answer: In his great mercy he has given us new birth into a living hope through the resurrection of Jesus Christ from the dead. 1 Peter 1:3, NIV

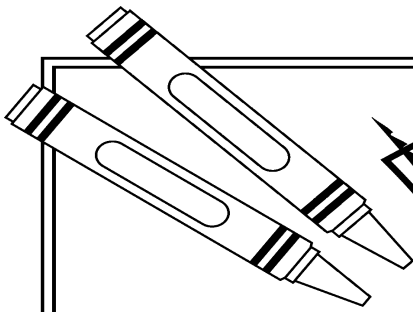

PUZZLE

RESURRECTION HOPE



Romans 6:5 reveals the hope we have because Jesus rose from the dead on Easter.



Directions: First solve the math problems. Then put the corresponding words in the blanks; for example, the word next to the answer "1" goes in the first blank, the word next to the answer "2" goes in the second blank, and so on.

- | | | |
|---------------------|------------------|------------------------|
| 2+2 = ___ united | 2x3 = ___ death | 7+6 = ___ resurrection |
| 3x3 = ___ certainly | 18-16 = ___ have | 4-1 = ___ been |
| 0+1 = ___ if | 2x4 = ___ we | 13-1 = ___ him |
| 2+3 = ___ in | 20-6 = ___ like | 2+5 = ___ his |
| 2x5 = ___ be | 8+3 = ___ with | |

“For 1 we 2 3 4
 with him 5 a 6 like 7 ,
8 will 9 also 10 united
11 12 in a 13
14 his.” Romans 6:5, NIV

Answer: For if we have been united with him in a death like his, we will certainly also be united with him in a resurrection like his. Romans 6:5, NIV

On the Lighter Side

Using the right words

"How did you like the evangelist's sermon?" Mrs. Brown asked her husband on the way home from church.
 "Well, frankly, I like our own minister's better," he said.
 "Why is that?" his wife wanted to know.
 "It's the words they use," explained Mr. Brown. "Our preacher says, 'In conclusion,' and then he concludes. The evangelist says 'Lastly,' and then he lasts!"

-Tal D. Bonham in Treasury of Clean Church Jokes

As of April 12

Keep in your Prayers

Chris Clark, Marta Mojzer's cousin
 Barb Emmerich, Diane Kosey's cousin
 Jeff, Deb Schoenherr's son
 Sandy Thien, Ginny Kramer's niece
 Pam Kelso, Carol Kiphart's daughter
 Megan, Nadine Jones' granddaughter

Vickie Murrell, Harrings' request
 Jack Kraft, K. Kessler request
 *Springdale police officers, Fran Thomas

*People of Nashville
 *Caleb Erickson, D. Hess request
 *John Marshall, D. Hess request
 Fran Thomas
 Natasha, B. Pratt request
 Jean Parsley
 Pam Harring
 George Liles
 Dee Burkhardt
 Diane Niehaus, B. Luebbe request
 Gerald Reese, M. Reese's father
 Margie, Fran Thomas' sister
 All peoples in the Middle East
 All Elected Government leaders
 Support for all our military
 For all missionaries (Especially for S. and B.)

Healing/cancer has returned
 Healing/recovery major heart attack
 For good test results
 Healing/cancer/chemo treatments beginning
 Healing/diagnosed with cancer
 God's Providence and care/mother of twins needs
 bone marrow transplant
 Healing/recovering from heart surgery
 Healing/severe leg infection
 Bereavement for the loss of one officer;
 Healing for the injured second officer
 God's providence and comfort
 Continued healing/fighting infection
 Healing/dialysis and tumor concerns
 Healing/pain relief
 Healing/recovery surgery on legs
 Continued healing
 Continued healing/guidance with treatment
 Continued healing/home recovering
 Continued healing
 Continued healing/several health concerns
 Continued healing/swallowing problems
 God's peace and comfort
 Peace and reconciliation
 Wisdom/support/enlightenment
 Strength/discernment/God's protection
 Protection/blessings/fruitful mission work

Names that have been on the Prayer List for more than 4 weeks are marked with an asterisk ().
 If you would like them to remain on the list, please contact the office by Tuesday.*

Financial Information

Donations Received as of 3/29	\$2,047
Per Capita 2020 Donations	\$528
Property Fund Giving 2020	\$3,000
Property Fund Goal 2020	\$5,000

Per Capita for 2020 is \$33

**Rev. Tom Dunlap will be preaching
 the month of April.**

**Please follow his sermons on-line.
 See page 3 for details.**